



ZHENGZHOU LERFORD MACHINERY EQUIPMENT CO.,LTD

Tel:0371 55960109

Fax: 86 371 55960109

Mobile:+8615838007835

Website:www.rxpelletmilling.com

E-mail: susan@pelletmilling.com

Whatsapp:+86-15838007835

Introduction

A log splitter is a highly efficient mechanical equipment designed specifically for processing logs. It is primarily used to split various types of logs and stumps into wood suitable for use. Based on its functional configuration, it is divided into two core series – models with cutting functions and models without cutting functions. According to the method of use, it can be divided into vertical and horizontal types. The power source can be electric motor, diesel engine, or gasoline engine, accurately matching the wood processing needs of different users. It completely replaces traditional manual axe splitting and sawing, achieving efficient, safe, and convenient wood processing. Whether you are a logging company or processing plant that needs to process logs in bulk, or a household user who needs to stockpile firewood, you can find a suitable option among our products. Please feel free to contact us for inquiries and purchases.



Type



ZHENGZHOU LERFORD MACHINERY EQUIPMENT CO.,LTD

Tel:0371 55960109
 Mobile:+8615838007835
 E-mail: susan@pelletmilling.com

Fax: 86 371 55960109
 Website:www.rxpelletmilling.com
 Whatsapp:+86-15838007835

Our log splitters can be customized with three power sources: electric motor, gasoline engine, or diesel engine (diesel engine models are slightly more expensive). Smaller models support custom log splitting lengths. Custom specifications vary for each model; please contact our sales team for detailed information and a satisfactory solution.

			
RX-8T	RX-8T(With protective case)	RX-13T	RX-15T
			
RX-18T (Single)	RX-18T(Double)	20T	25T
			
28T	30T	50T	Sawmill production line



ZHENGZHOU LERFORD MACHINERY EQUIPMENT CO.,LTD

Tel:0371 55960109

Fax: 86 371 55960109

Mobile:+8615838007835

Website:www.rxpelletmilling.com

E-mail: susan@pelletmilling.com

Whatsapp:+86-15838007835

rx-8t



Specification Name	Parameter	Specification Name	Parameter
Product Outer Dimensions (L×W×H mm)	1010×285×485	Log Diameter (mm)	50–400
Net Machine Weight (including hydraulic oil kg)	43.5	Control Valve	Single-hand valve
Packaging Dimensions (L×W×H mm)	1030×290×560	Maximum Tonnage	8T
Total Gross Weight of Packaging (kg)	54.5	Hydraulic Oil Type	32#/46#
Horizontal / Vertical Type	Horizontal	Tire Size (inches)	6
Splitting Method	2-way /4-way (optional)	Hydraulic Oil	3.6L
Cycle Time	11s	Cylinder Inner Diameter (mm)	55
Operating Voltage / Hz	220V /50Hz	Piston Rod Diameter (mm)	30
Motor Power	2.2kW	OEM	Supported
Protection Rating	IP54	Consumer Warranty	1 Year



ZHENGZHOU LERFORD MACHINERY EQUIPMENT CO.,LTD

Tel:0371 55960109

Fax: 86 371 55960109

Mobile:+8615838007835

Website:www.rxpelletmilling.com

E-mail: susan@pelletmilling.com

Whatsapp:+86-15838007835

Log Length (mm)	560		
-----------------	-----	--	--

rx-13t			
Product Outer Dimensions (mm)	1770*760*780	Motor Power	2.2 kW
Net Machine Weight (kg)	98	Protection Rating	IP54
Packaging Dimensions (mm)	1380*330*635	Wood Cutting Length (mm)	550
Gross Packaging Weight (kg)	114	Wood Diameter (mm)	50 鈇00
Type (Horizontal / Vertical)	Horizontal	Control Handle	Dual-hand Safety Switch
Cutting Method	2-path Single Blade	Maximum Unit Capacity	13T
Cycle Time	2s	Tire Size (inch)	8
Operating Voltage / Hz	220V /50Hz	OEM Support	Supported

rx-15t			
--------	---	--	--



ZHENGZHOU LERFORD MACHINERY EQUIPMENT CO.,LTD

Tel:0371 55960109

Fax: 86 371 55960109

Mobile:+8615838007835

Website:www.rxpelletmilling.com

E-mail: susan@pelletmilling.com

Whatsapp:+86-15838007835

Specification Name	Parameter	Specification Name	Parameter
Cycle Time	8S	Max Split Length	610mm
Max Split Diameter	400mm	Work Efficiency	4-7 CBM/H
Power	15HP Gasoline Engine	Engine Displacement	420cc
Fuel Tank Capacity	6.6L	Engine Oil Capacity	1.1L
Total Torque	25N.m/2500rpm	Chain Saw Length	22"
Chain Saw Speed	5600rpm	Cutting Speed	Adjustable
Oil Pump	22GMP,2-stage	Oil Tank Capacity	50L
Control Valve1	Single Handle	Tire	12"
Control Valve2	4-Way Control Valve	Blade	4-way /6-way Optional
Wood Conveyor Length	3.2m	Conveyor Belt Width	250mm
Conveyor Groove Width	400mm	Conveyor Hydraulic Rotator	1 Set
Weight	500kg	Product Dimensions	2000x100x1500mm



ZHENGZHOU LERFORD MACHINERY EQUIPMENT CO.,LTD

Tel:0371 55960109

Fax: 86 371 55960109

Mobile:+8615838007835

Website:www.rxpelletmilling.com

E-mail: susan@pelletmilling.com

Whatsapp:+86-15838007835

rx-18t			
Parameter Type	Parameter	Parameter Type	Parameter
Product External Dimensions (Length/Width/Height*MM)	1920/640/860	Working Pressure	20MP-28MP Adjustable
Machine Weight (Including Hydraulic Oil KG)	110	ODM	Acceptable
Packaging Dimensions (Length/Width/Height*MM)	1255/580/580	Warranty Period	1 Year
Total Packaging Weight (KG)	130	Engine Dimensions (Length x Width x Height)	390*320*345
Layout Type	Horizontal	Engine Type	Air-Cooled4-Stroke Gasoline Engine, OHV
Division Method	2-Stage	Engine Displacement	7HP209CC
Cycle	85	Engine Orientation	Horizontal Shaft
Pump Model / Flow Rate L/min	CBNA-13/1.8D /46.8	Starting Method	Manual/Electric (Optional)
Control Valve	100L Three-Position Four-Way Return-to-Center	Rated Torque* (N.m/rpm)	12/2500
Maximum Tonnage	18T	Cylinder	Single Cylinder, Steel Cylinder Sleeve



ZHENGZHOU LERFORD MACHINERY EQUIPMENT CO.,LTD

Tel:0371 55960109

Fax: 86 371 55960109

Mobile:+8615838007835

Website:www.rxpelletmilling.com

E-mail: susan@pelletmilling.com

Whatsapp:+86-15838007835

Hydraulic Oil Grade	32#/46#	Engine Oil Tank Capacity	3.6L
Wheel Diameter (Inches)	10	Cylinder Bore (MM)	70
Minimum Hydraulic Oil Level Scale	3	Oil Capacity (L)	0.55
Maximum Hydraulic Oil Level Scale	6	Stroke (MM)	55
Cylinder Inner Diameter (MM)	80	Net Weight (KG)	16
Shearing Stroke (MM) (Customizable)	660		

RX-18T (Double, With Lifting Mechanism)			
Specification Name	Parameter	Specification Name	Parameter
Product Outer Dimensions (L×W×H mm)	2230×680×960	Filter	Oil Absorption Filter
Bare Machine Weight (including hydraulic oil, kg)	195	Engine Lubrication System	Forced Oil Cooling
Packing Dimensions (L×W×H mm)	1410×580×715	Engine Type	Single-cylinder, Four-stroke (OHV)



ZHENGZHOU LERFORD MACHINERY EQUIPMENT CO.,LTD

Tel:0371 55960109

Fax: 86 371 55960109

Mobile:+8615838007835

Website:www.rxpelletmilling.com

E-mail: susan@pelletmilling.com

Whatsapp:+86-15838007835

Total Packing Weight (kg)	225	Engine Bore × Stroke	70×55 (mm)
Wood Clamp Frame	Manual Adjustable Bracket	Engine Displacement	202ml
Splitting Method	2-way /4-way Hydraulic Automatic Lift and Lower	Engine Compression Ratio	9.0:1
Cycle Time	9s	Engine Net Power	4.4kW /3600rpm
Oil Pump Model	CBNA-13/1.8D1J746806/46.8	Engine Net Torque	12N·m /2500rpm
Control Valve1	100L Three-position Automatic Return	Engine PTO Shaft Rotation Direction	Counterclockwise (Horizontal Shaft Output)
Maximum Tonnage	18T	Engine Ignition System	Electromagnetic Ignition
Hydraulic Oil Grade	32# /46#	Engine Lubrication System	Manual / Electric

RX-20T			
Specification Name	Parameter	Specification Name	Parameter
Cycling Time	8S	Maximum Split Length	610mm



ZHENGZHOU LERFORD MACHINERY EQUIPMENT CO.,LTD

Tel:0371 55960109

Fax: 86 371 55960109

Mobile:+8615838007835

Website:www.rxpelletmilling.com

E-mail: susan@pelletmilling.com

Whatsapp:+86-15838007835

Maximum Split Diameter	400mm	Working Efficiency	5CBM/H
Power	13.5HP Gasoline Engine	Engine Displacement	420cc
Fuel Tank Capacity	6.6L	Engine Oil Capacity	1.1L
Total Torque	25N.m/2500rpm	Chain Length	22"
Chain Speed	5600rpm	Saw Speed	Adjustable
Oil Pump	22GMP,2-stage	Oil Tank Capacity	50L
Control Valve1	Single Handle	Tire	12"
Control Valve2	4-Way Control Valve	Knife	4-way /6-way selectable
Wood Conveyor Length	3.2m	Conveyor Belt Width	250mm
Conveyor Sliding Groove Width	400mm	Conveyor Belt Rotary Drive	1 set
Weight	510kg	Main Unit Packaging Size	2200x900x1100mm
Conveyor Packaging Size	2260*960*1170mm		



ZHENGZHOU LERFORD MACHINERY EQUIPMENT CO.,LTD

Tel:0371 55960109

Fax: 86 371 55960109

Mobile:+8615838007835

Website:www.rxpelletmilling.com

E-mail: susan@pelletmilling.com

Whatsapp:+86-15838007835

RX-25T			
Parameter Type	Parameter	Parameter Type	Parameter
Product External Dimensions (L/W/H * MM)	2170/890/985	Tire	4.8-8
Bare Weight (KG)	205	Brake	American2" Disc Brake
Packaging Dimensions (L/W/H * MM)	1210/565/840	Minimum Oil Level of Hydraulic Oil	9L
Total Packaging Weight (KG)	223	Maximum Oil Level of Hydraulic Oil	16L
Layout / Style	Standing or Lying (Dual Use)	Cylinder Bore Diameter (MM)	100
Splitting Method (Optional)	2-Lane /4-Lane	Shear Stroke (MM) (Customizable)	670
Cycle Time	11S	Working Pressure	20MP-32MP Adjustable
Oil Pump Model / Flow Rate (L/min)	CBNA-13/1.8D	OEM	Acceptable
Control Valve	100L Three-Way Automatic Valve	Engine Shaft Orientation2	Horizontal Shaft
Maximum Number of Heads	25T	Engine Type	Wind-Cooled Four-Stroke Gasoline Engine
Hydraulic Oil Grade	#46	Engine Displacement	6.5P211CC



ZHENGZHOU LERFORD MACHINERY EQUIPMENT CO.,LTD

Tel:0371 55960109
 Mobile:+8615838007835
 E-mail: susan@pelletmilling.com

Fax: 86 371 55960109
 Website:www.rxpelletmilling.com
 Whatsapp:+86-15838007835

Oil Filter	Yes		
------------	-----	--	--



Specification Name	Parameter	Specification Name	Parameter
Product Dimensions (L×W×H mm)	2800×1430×1170	Control Valve2	40L Single-acting Manual Valve
Bare Machine Weight (including hydraulic oil kg)	295	Towing	None
Packaging Dimensions (L×W×H mm)	1500×665×880	Engine Type	Single cylinder, Four-stroke (OHV)
Total Gross Weight of Packaging (kg)	225	Engine Bore × Stroke	70×55 (mm)
Wood Holder Frame	Hydraulic Automatic Lifting Wood Support	Engine Displacement	212 cm ³
Splitting Method	2-way /4-way Hydraulic Automatic Lifting	Engine Compression Ratio	9.0:1
Cycle Time	10s	Engine Net Power	4.4kW /3600rpm
Oil Pump Model	CBNA-13/1.8D1J746806/46.8	Engine Torque	12N·m /2500rpm



ZHENGZHOU LERFORD MACHINERY EQUIPMENT CO.,LTD

Tel:0371 55960109

Fax: 86 371 55960109

Mobile:+8615838007835

Website:www.rxpelletmilling.com

E-mail: susan@pelletmilling.com

Whatsapp:+86-15838007835

Control Valve1	100L Three-position Auto-return	Direction of Engine PTO Shaft Rotation	Counter-clockwise (Horizontal Output)
Maximum Tonnage	28T	Ignition System	Electric Spark Ignition
Hydraulic Oil Grade	32#/46#	Starting System	Manual / Electric
Filter	Suction Oil Filter	Lubrication System	Forced Splash
Tire Model	4.80-8 (Tubeless Tire)	Oil System	Centrifugal Oil Filter
Minimum Hydraulic Oil Level	16L	Speed Control System	Centrifugal Governor
Maximum Hydraulic Oil Level	22L	Air Filter	Dual-layer Filter (Paper or Foam)
Cylinder Inner Diameter (mm)	100	Engine Oil Capacity	0.55L
Log Length (mm)	703 (Customizable)	Oil Pan Capacity	3.6L
Working Pressure (MPa)	20-28 (Adjustable)	Engine Dimensions (L×W×H)	390×320×345
OEM	Supported	Engine Net Weight	16kg
Consumer Warranty	1 Year	Fuel Consumption	≤395g/kW·h



ZHENGZHOU LERFORD MACHINERY EQUIPMENT CO.,LTD

Tel:0371 55960109

Fax: 86 371 55960109

Mobile:+8615838007835

Website:www.rxpelletmilling.com

E-mail: susan@pelletmilling.com

Whatsapp:+86-15838007835

RX-30T			
Specification Name	Parameter	Specification Name	Parameter
Maximum splitting force	30T	Maximum cutting length	610mm
Cycle time	8s	Maximum splitting diameter	500mm
Working efficiency	4-8CBM/H	Power source	27HP gasoline engine
Weight	1100kg	Engine displacement	680cc
Fuel capacity	6.5L	Engine oil capacity	1.1L
Wood conveyer length	3.2m	Conveyor belt width	370mm
Conveyor chute width	400mm	Hydraulic rotary actuator	1 set
Chain saw length	22"	Chain saw speed	7000rpm
Cutting speed	Adjustable	Oil pump	22GMP,2-stage
Splitting method	4/6/8 paths	价格	

Workflow

The standard workflow of this log splitter is as follows: The logs must first be pre-cut into suitable lengths according to specifications (refer to the maximum cutting length provided for each model) before the machine can operate normally. However, some models (such as RX-15T, RX-20T, and RX-30T) have an integrated chainsaw cutting



ZHENGZHOU LERFORD MACHINERY EQUIPMENT CO.,LTD

Tel:0371 55960109

Fax: 86 371 55960109

Mobile:+8615838007835

Website:www.rxpelletmilling.com

E-mail: susan@pelletmilling.com

Whatsapp:+86-15838007835

function, allowing for integrated cutting and feeding. Then, the hydraulic system applies directional high pressure to quickly split the wood along the grain into multiple pieces, achieving efficient and continuous automated operation..



Raw timber



Step 1



Finished Product

Applicable Scenarios



ZHENGZHOU LERFORD MACHINERY EQUIPMENT CO.,LTD

Tel:0371 55960109

Fax: 86 371 55960109

Mobile:+8615838007835

Website:www.rxpelletmilling.com

E-mail: susan@pelletmilling.com

Whatsapp:+86-15838007835

The automatic log splitter can quickly and efficiently cut logs into multiple smaller pieces without requiring much effort. This log splitter boasts high adaptability and versatility for various applications: it efficiently handles initial log processing in forestry and logging operations; it supports large-scale, continuous splitting in sawmills, increasing timber yield; and in home gardens, it combines safety, convenience, and low noise design to meet daily firewood preparation needs – truly achieving multi-purpose use from professional forests to backyard use.



Forestry



Logging



Household Use



Lumber Mill



ZHENGZHOU LERFORD MACHINERY EQUIPMENT CO.,LTD

Tel:0371 55960109

Fax: 86 371 55960109

Mobile:+8615838007835

Website:www.rxpelletmilling.com

E-mail: susan@pelletmilling.com

Whatsapp:+86-15838007835

Detail Display:

RX-8T



RX-13T Log Splitting Length 560mm, both models are customizable



Two Views

RX-18T Structural Diagram

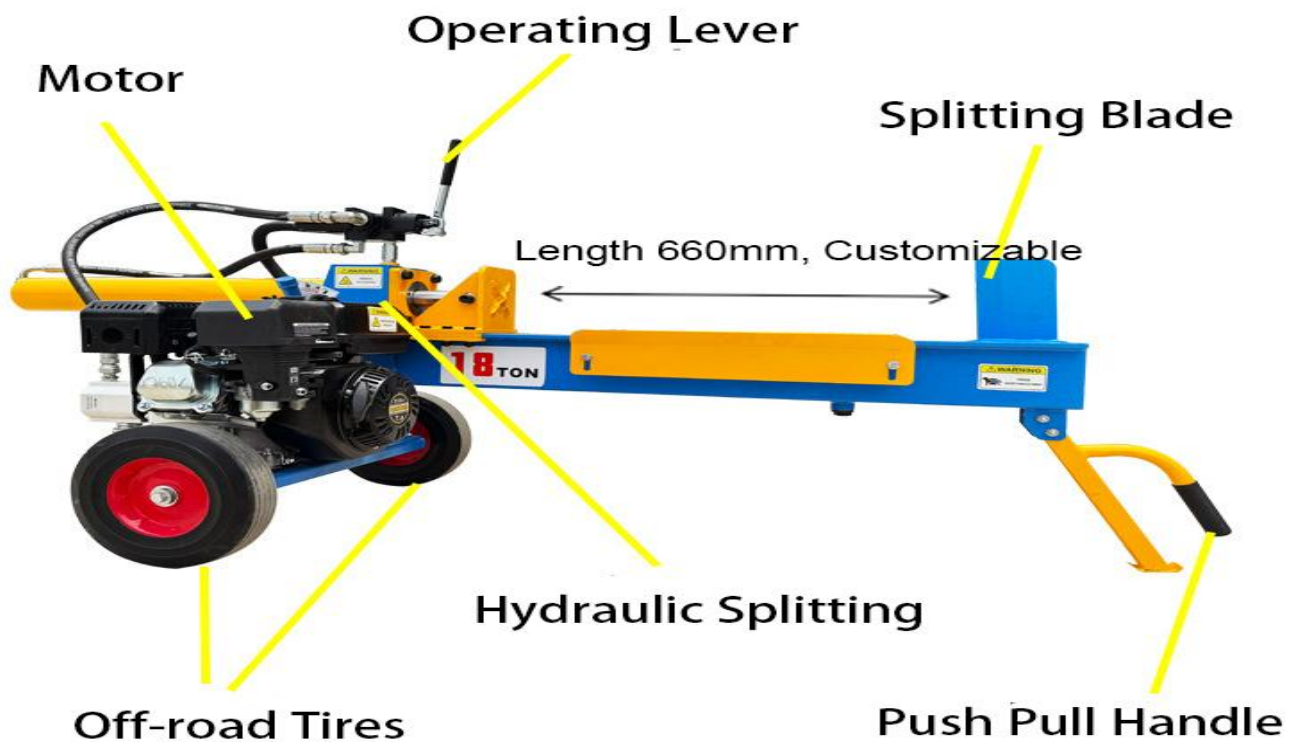



ZHENGZHOU LERFORD MACHINERY EQUIPMENT CO.,LTD

Tel:0371 55960109

Fax: 86 371 55960109

Mobile:+8615838007835

Website:www.rxpelletmilling.com

E-mail: susan@pelletmilling.com

Whatsapp:+86-15838007835

RX-25T



Horizontal/Vertical Working

RX-28T

Splitting Blade Automatically Adjustable

Hydraulic Rod Operation

Engine

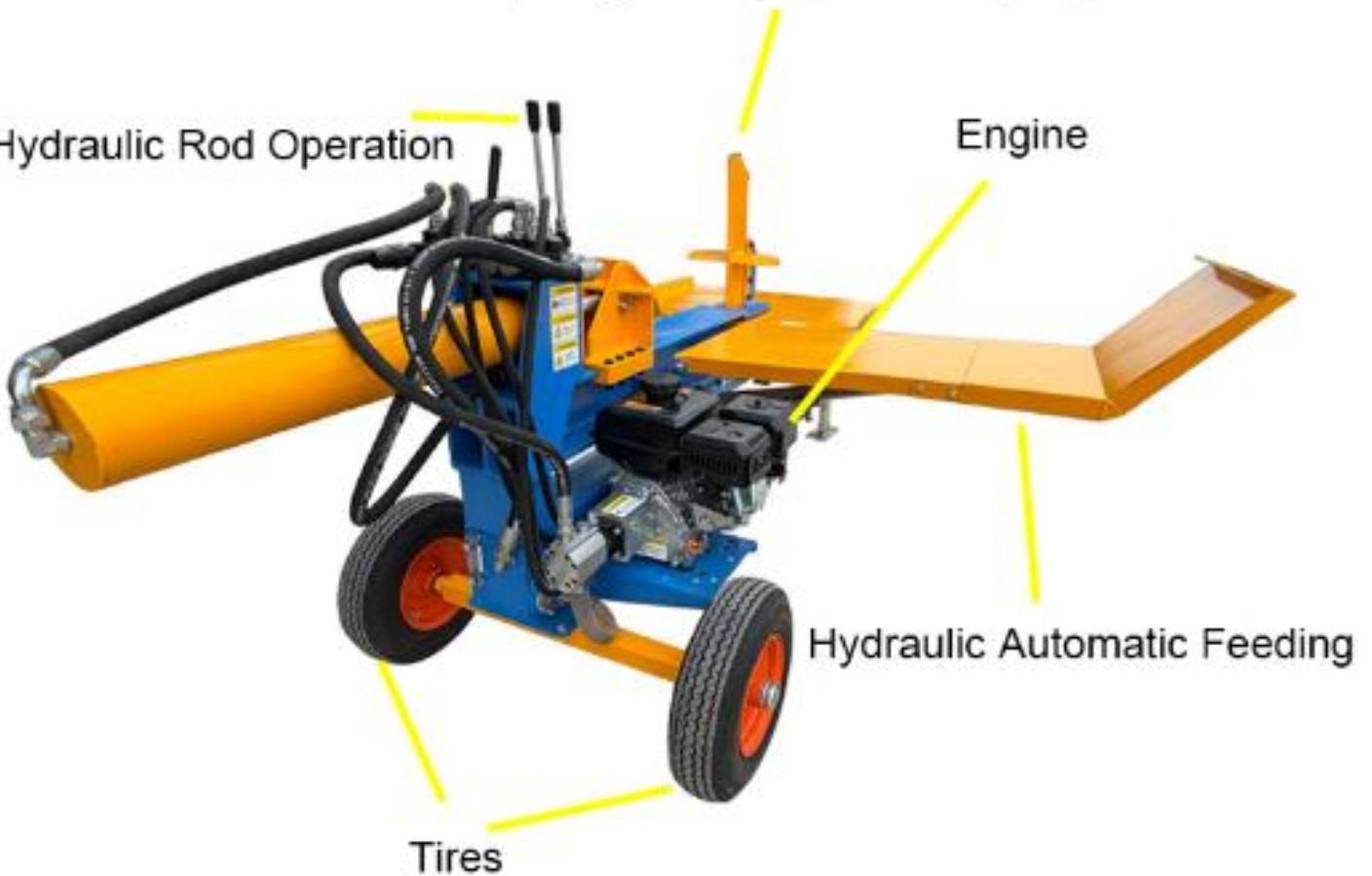

Hydraulic Automatic Feeding

Tires



ZHENGZHOU LERFORD MACHINERY EQUIPMENT CO.,LTD

Tel:0371 55960109

Fax: 86 371 55960109

Mobile:+8615838007835

Website:www.rxpelletmilling.com

E-mail: susan@pelletmilling.com

Whatsapp:+86-15838007835

RX-15T

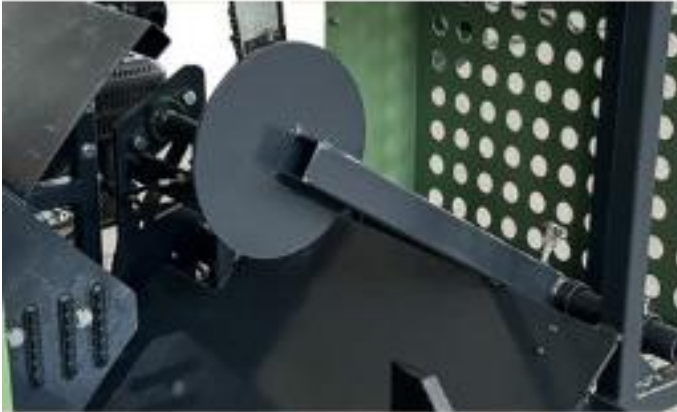

Adjustable Cutting Length



Automatic Feeding



Blade lifting/lowering



Portable log clamping



Portable loading rack



Imported chain



ZHENGZHOU LERFORD MACHINERY EQUIPMENT CO.,LTD

Tel:0371 55960109

Fax: 86 371 55960109

Mobile:+8615838007835

Website:www.rxpelletmilling.com

E-mail: susan@pelletmilling.com

Whatsapp:+86-15838007835

Portable loading rack

Imported chain



RX-20T





ZHENGZHOU LERFORD MACHINERY EQUIPMENT CO.,LTD

Tel:0371 55960109

Fax: 86 371 55960109

Mobile:+8615838007835

Website:www.rxpelletmilling.com

E-mail: susan@pelletmilling.com

Whatsapp:+86-15838007835



Hydraulic automatic log clamping



Automatic feeding conveyor system



Adjustable wood length
Supports four or six directions



Fully automatic control system



Automatic protection device



Imported chain



ZHENGZHOU LERFORD MACHINERY EQUIPMENT CO.,LTD

Tel:0371 55960109

Fax: 86 371 55960109

Mobile:+8615838007835

Website:www.rxpelletmilling.com

E-mail: susan@pelletmilling.com

Whatsapp:+86-15838007835

RX-30T



Four Tires



Splitting Blade is Adjustable



Automatic protection device

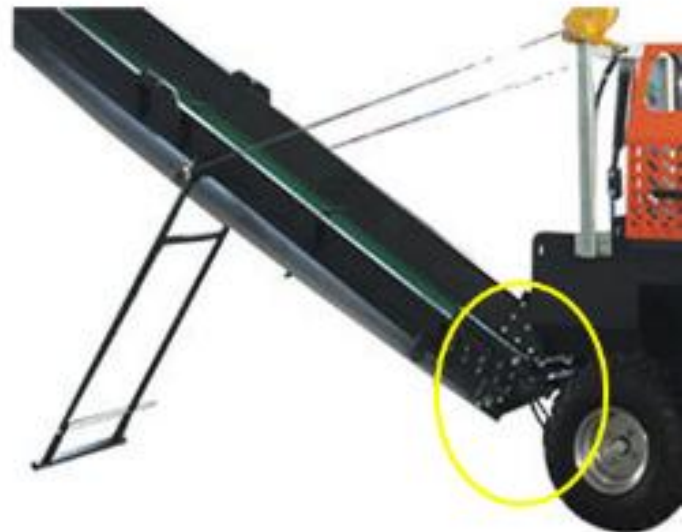

Control of Discharge Direction



ZHENGZHOU LERFORD MACHINERY EQUIPMENT CO.,LTD

Tel:0371 55960109

Fax: 86 371 55960109

Mobile:+8615838007835

Website:www.rxpelletmilling.com

E-mail: susan@pelletmilling.com

Whatsapp:+86-15838007835

Factory Showcase



Comparison:

Compared to manual wood splitting, a log splitter is more labor-saving, efficient, and safer; one person operating it can do the work of several people.



ZHENGZHOU LERFORD MACHINERY EQUIPMENT CO.,LTD

Tel:0371 55960109

Fax: 86 371 55960109

Mobile:+8615838007835

Website:www.rxpelletmilling.com

E-mail: susan@pelletmilling.com

Whatsapp:+86-15838007835



How to pack?

Our Log Splitter carefully select custom-made boxes made from high-strength solid wood to ensure packaging stability from the start. This wood undergoes rigorous drying to maintain a reasonable moisture content, effectively preventing deformation and cracking caused by humidity fluctuations. This ensures the boxes maintain structural integrity during long-distance transportation and storage.









ZHENGZHOU LERFORD MACHINERY EQUIPMENT CO.,LTD

Tel:0371 55960109 Fax: 86 371 55960109
 Mobile:+8615838007835 Website:www.rxpelletmilling.com
 E-mail: susan@pelletmilling.com Whatsapp:+86-15838007835

What related products are there

			
Timber Trailer with Crane	Saw blade sharpener	Log lifter	log table

How about the customer feedback?

Feedback

Have a nice weekend. 下午2:25 ✓ 评价对象 评分&评论

Hello,
Thanks you!
Last week we took the shelling mact from the port. Thanks a lot to all your team for good cooperation and supp
Success to all!! Have a good weeke

订单号: 034-200-457530 最近更新时间: 2017-05-07 23:51

office from today,any questions or needs about our machine,contact me without any hesitation,Best regards for all of your family. 10:40 ✓

Very Impressive ! Great Quality and Fast shipn parts very quick and in great condition. 4 days alia, it is a remarkable record . Happy to d Gaston

Good morning Susan,nice holiday all the best for you and ur family the Golden Machinery is the best Machines all over the world

Best regards from me 🌹🌹🌹🌹🌹 10:23

U: We are brother between Iran and China 下午7:33 ✓

I really appreciate you without doing any business you are so good friend 下午7:35

can find the point and open Any questions or help,conta

yes if we need buy any machine we only choose your machine

My son and his dad 10:44 ✓

I really enjoy with machine 🍌🍌🍌 10:45

如约发货 ✓ 收货后质量保障 ✓

13.About us



ZHENGZHOU LERFORD MACHINERY EQUIPMENT CO.,LTD

Tel:0371 55960109
Mobile:+8615838007835

Fax: 86 371 55960109
Website:www.rxpelletmilling.com
Whatsapp:+86-15838007835



Golden Supplier



SGS



Top 1 Alibaba Supplier





ZHENGZHOU LERFORD MACHINERY EQUIPMENT CO.,LTD

Tel:0371 55960109
Mobile:+8615838007835
E-mail: susan@pelletmilling.com

Fax: 86 371 55960109
Website:www.rxpelletmilling.com
Whatsapp:+86-15838007835



9.How about cooperation client?





ZHENGZHOU LERFORD MACHINERY EQUIPMENT CO.,LTD

Tel:0371 55960109
Mobile:+8615838007835
E-mail: susan@pelletmilling.com

Fax: 86 371 55960109
Website:www.rxpelletmilling.com
Whatsapp:+86-15838007835

Customer visits



aARMENIA



Tanzania



Côte d'Ivoire



Germany



Congo



Cameroon



South Africa



Ethiopia



Thailand



Uzbekistan



India



Ghana

14.Our Certification:

